

Article number: 25150662002

Description: ICME Single-phase motor MD100 B6 1,5KW
6 - 900 rpm 1x230 Volt 50Hz B3 with starting & running capacitor

Measures

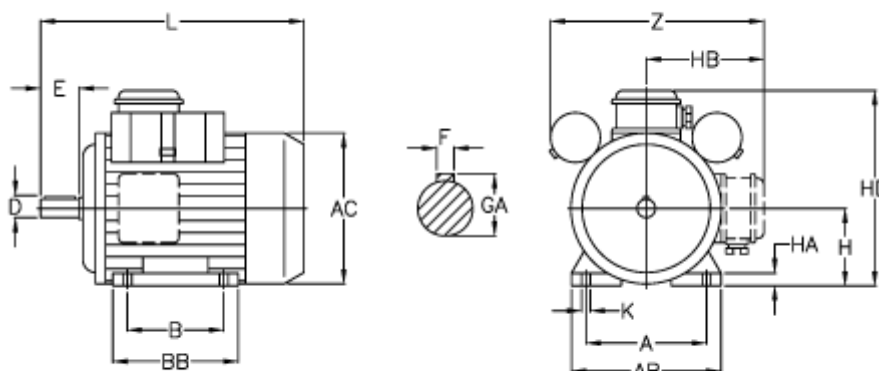

A = 160	H = 100
AB = 200	HA = 14
AC = 195	HB = 140
B = 140	K = 12
D = 28	L = 403
E = 60	Z = 260
F = 8	
GA = 31	